



Inline sensor-fitting with paddle wheel for flow measurement

- DN06 to DN65
- Wide range of materials and type of process connections available to ideally fit to the individual applications and process conditions
- Closed pipe system, sensor inside fitting
- Quarter-turn technology
- Transmitter available for
 - Indication, Monitoring, Transmitting
 - On/Off control, Batch control

Product variants described in the data sheet may differ from the product presentation and description.

Can be combined with

	Type SE30 Transmitter for Inline sensor-fitting	▶
	Type SE32 Transmitter for Inline sensor-fitting	▶
	Type SE35 Transmitter or batch controller for Inline sensor-fitting	▶
	Type SE36 ELEMENT transmitter for Inline sensor fitting	▶
	Type 8611 eCONTROL - Universal controller	▶

Type description

The sensor-fitting Type S030 has a built-in paddle wheel to measure the flow rate and is especially designed for use with neutral, slightly aggressive, solid free liquids.

The compact sensor-fitting (S030) must be equipped with a Bürkert transmitter (SE30, SE30 Ex, SE32, SE35, SE36 or 8611) quickly and easily connected together by a bayonet catch. The Bürkert "Inline quarter-turn" technology is a construction ensuring a leakage free operation.

The paddle wheel rotation (permanent magnets included in the wheels) is detected contactless through the sensor-fitting wall. The transmitter can be snapped-on or removed without opening the pipe or interrupting the process.

Table of contents

1. General technical data	3
2. Approvals	4
2.1. Certification FDA.....	4
2.2. Pressure Equipment Directive.....	4
Device used on a pipe	4
3. Materials	5
3.1. Chemical Resistance Chart – Bürkert resistApp.....	5
3.2. Material specifications	5
4. Dimensions	6
4.1. Metal sensor-fitting.....	6
Internal thread connection.....	6
External thread connection.....	6
Weld end connection.....	7
Clamp connection.....	8
Flange connection	9
4.2. Plastic sensor-fitting	9
True union connection with nut and solvent/fusion socket	9
Solvent/fusion spigot connection	10
5. Performance specifications	10
5.1. Pressure temperature diagram.....	10
6. Product installation	11
6.1. Installation notes.....	11
6.2. Selection of the nominal diameter	11
7. Product operation	12
7.1. Measuring principle	12
8. Product design and assembly	13
8.1. Product assembly	13
9. Product accessories	13
10. Networking and combination with other Bürkert products	14
11. Ordering information	15
11.1. Bürkert eShop – Easy ordering and quick delivery.....	15
11.2. Recommendation regarding product selection	15
11.3. Bürkert product filter.....	15
11.4. Ordering chart.....	16
Metal sensor-fitting.....	16
Plastic sensor-fitting	17
11.5. Ordering chart accessories.....	18

1. General technical data

Product properties	
Materials	
Please make sure the device materials are compatible with the fluid you are using. Detailed information can be found in chapter “3.1. Chemical Resistance Chart – Bürkert resistApp” on page 5.	
Wetted parts	
Body, sensor armature	Stainless steel (316L - 1.4404), brass (CuZn ₃₉ Pb ₂), PVC, PP, PVDF (depending on S030 version)
Seal	FKM or EPDM (depending on S030 version). Detailed information can be found in chapter “11.4. Ordering chart” on page 16
Axis and bearings	Ceramics (Al ₂ O ₃)
Paddle wheel	PVDF (PP or stainless steel on request, detailed information about stainless steel paddle wheel, see data sheet Type 8030HT ▶)
Screws	Stainless steel (316L - 1.4404)
Dimensions	Detailed information can be found in chapter “4. Dimensions” on page 6
Compatibility	With flow transmitter Type SE30, SE30 Ex, SE32, SE35, SE36, batch controller SE35 or 8611 Universal controller
Pipe diameter	DN06...DN65
Performance data	
Measuring range	0.5...1200 l/min
Measurement deviation	Teach-In (via a remote transmitter): ± 1 % of the measured value ¹⁾ (at Teach-In flow rate value) Standard K-factor: ± 2.5 % of the measured value ¹⁾
Linearity	± 0.5 % of full scale ¹⁾
Repeatability	± 0.4 % of the measured value ¹⁾
Medium data	
Fluid	Clean, neutral or slightly aggressive, solid-free liquids
Pollution	Max. 1 %, size of particles 0.5 mm max.
Viscosity	300 cSt. max.
Velocity	0.3...10 m/s Detailed information can be found in chapter “6.2. Selection of the nominal diameter” on page 11.
Fluid temperature	For sensor-fitting in: PVC: 0...+50 °C (+32...+122 °F) PP: 0...+80 °C (+32...+176 °F) Stainless steel, brass or PVDF: -15...+100 °C (+5...+212 °F) f
Fluid pressure (max.)	PN10 for plastic sensor-fitting PN16 for metal sensor-fitting. Detailed information can be found in chapter “5.1. Pressure temperature diagram” on page 10.
Approvals and Certificates	
Directives	
CE directives	The applied standards, which verify conformity with the EU Directives, can be found on the EU Type Examination Certificate and/or the EU Declaration of conformity (if applicable)
Pressure equipment directives	Complying with Article 4, Paragraph 1 of 2014/68/EU directive. Detailed information on the pressure equipment directive can be found in chapter “2.2. Pressure Equipment Directive” on page 4.
Certificates	Certificates must be ordered separately. Detailed information can be found in chapter “11.5. Ordering chart accessories” on page 18 <ul style="list-style-type: none"> • Inspection certificate 3.1 (acc. to EN-ISO 10204) • Test report 2.2 (acc. to EN-ISO 10204) • Certification of Conformity for the surface Quality (DIN4762-DIN4768-ISO/4287/1) • 3 points Flow calibration certificate • FDA declaration of conformity (stainless steel fitting only with EPDM seal)
Product connections	
Process connection	Metal sensor-fitting: Internal or external thread, weld ends, Clamp or flange Plastic sensor-fitting: True union with nut and solvent/fusion socket, spigot or external thread

Environment and installation

Ambient temperature	Operation and storage: - 15...+60 °C (+5...+122 °F) for sensor-fitting in PVC - 15...+80 °C (+5...+176 °F) for sensor-fitting in PP - 15...+100 °C (+5...+212 °F) for sensor-fitting in stainless steel, brass or PVDF Temperature limits may depend on the inserted device. Refer to the relevant data sheet or instruction manual for more details.
---------------------	--

1.) Under reference conditions i.e. measuring fluid = water, ambient and water temperature = 20 °C (68 °F), while maintaining the minimum inlet and outlet distances and the appropriate internal diameters of the pipes.

2. Approvals

2.1. Certification FDA

Certificates	Description
	FDA The versions with the housing made of stainless steel materials and the seal made of EPDM materials comply in their composition with the Code of Federal Regulations published by the FDA (Food and Drug Administration, USA).

2.2. Pressure Equipment Directive

The device conforms to Article 4, Paragraph 1 of the Pressure Equipment Directive 2014/68/EU under the following conditions:

Device used on a pipe

Note:

- The data in the table is independent of the chemical compatibility of the material and the fluid.
- PS = maximum admissible pressure; DN = nominal diameter of the pipe

Type of fluid	Conditions
Fluid group 1, Article 4, Paragraph 1.c.i	DN ≤ 25
Fluid group 2, Article 4, Paragraph 1.c.i	DN ≤ 32 or PS*DN ≤ 1000
Fluid group 1, Article 4, Paragraph 1.c.ii	DN ≤ 25 or PS*DN ≤ 2000
Fluid group 2, Article 4, Paragraph 1.c.ii	DN ≤ 200 or PS ≤ 10 or PS*DN ≤ 5000

3. Materials

3.1. Chemical Resistance Chart – Bürkert resistApp

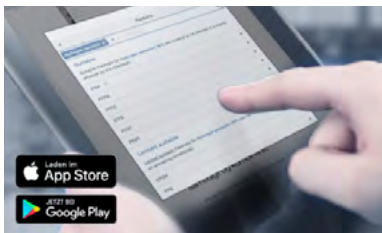

Bürkert resistApp – Chemical Resistance Chart

You want to ensure the reliability and durability of the materials in your individual application case? Verify your combination of media and materials on our website or in our resistApp.

[Start Chemical Resistance Check](#)

3.2. Material specifications

Note:

The drawing shows the sensor-fitting with a process True union connection with nut and solvent/fusion socket, but this also applies to all versions of process connection.

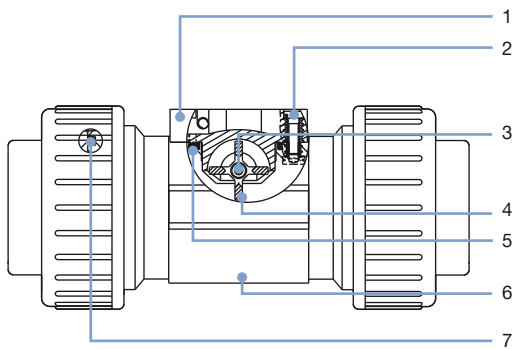

No.	Description	Material
1	Sensor armature	Stainless steel
2	Screws	Stainless steel
3	Axis and bearings	Ceramics (Al ₂ O ₃)
4	Paddle wheel	PVDF
5	Seal	FKM or EPDM (depending on S030 version)
6	Sensor-fitting body	Stainless steel (316L - 1.4404), brass (CuZn ₃₉ Pb ₂), PVC, PP, PVDF (depending on S030 version)
7	Seals	FKM or EPDM (depending on S030 version and only for True union connection with nut and solvent/fusion socket)

4. Dimensions

4.1. Metal sensor-fitting

Internal thread connection

Note:

Specifications in mm

G, NPT or Rc in stainless steel (316L - 1.4404) or brass (CuZn₃₉Pb₂)

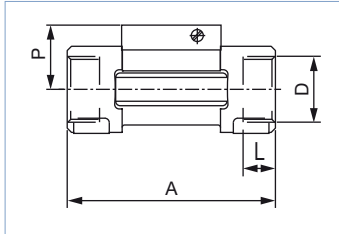

DN	P	A	D	L
			[inch]	
15	34.5	84.0	G ½	16.0
			NPT ½	17.0
			Rc ½	15.0
20	32.0	94.0	G ¾	17.0
			NPT ¾	18.3
			Rc ¾	16.3
25	32.2	104.0	G 1	23.5
			NPT 1	18.0
			Rc 1	18.0
32	35.8	119.0	G 1 ¼	23.5
			NPT 1 ¼	21.0
			Rc 1 ¼	21.0
40	39.6	129.0	G 1 ½	23.5
			NPT 1 ½	20.0
			Rc 1 ½	19.0
50	45.7	148.5	G 2	27.5
			NPT 2	24.0
			Rc 2	24.0

External thread connection

Note:

Specifications in mm

G, NPT or Rc in stainless steel (316L - 1.4404), brass (CuZn₃₉Pb₂), PVC (only DN06 and DN08) or PVDF (only DN08)

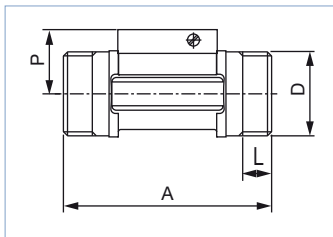

DN	P	A	D	L
			[inch]	
06	29.5	90.0	G ½	14.0
08	29.5	90.0	G, NPT or Rc ½	14.0
15	34.5	84.0	G ¾	11.5
20	32.0	94.0	G 1	13.5
25	32.2	104.0	G 1 ¼	14.0
32	35.8	119.0	G 1 ½	18.0

SMS 1145 in stainless steel (316L - 1.4404)

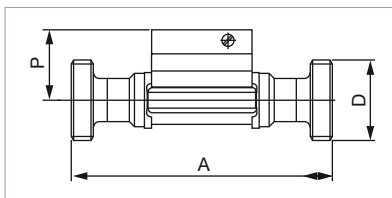

DN	P	A	D
25	32.0	130	Rd 40x1/6"
40	35.8	164	Rd 60x1/6"
50	39.6	173	Rd 70x1/6"

Weld end connection

Note:

Specifications in mm

EN ISO 1127/ISO 4200/DIN 11866 series B, SMS 3008, BS 4825-1/ASME BPE/DIN 11866 series C or DIN 11850 series 2/DIN 11866 series A/ DIN EN 10357 series A in stainless steel (316L - 1.4404)

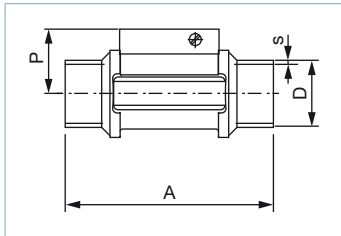

DN	P	A	Standard	D	s
08	-	-	EN ISO 1127/ISO 4200/DIN 11866 series B	-	-
	-	-	SMS 3008	-	-
	-	-	ASME BPE/DIN 11866 series C	-	-
	29.5	96.0	DIN 11850 series 2/DIN 11866 series A/ DIN EN 10357 series A	13.00	1.50
15	34.5	84.0	EN ISO 1127/ISO 4200/DIN 11866 series B	21.30	1.60
	-	-	SMS 3008	-	-
	-	-	ASME BPE/DIN 11866 series C	-	-
	34.5	84.0	DIN 11850 series 2/DIN 11866 series A/ DIN EN 10357 series A	19.0	1.50
20	32.0	94.0	EN ISO 1127/ISO 4200/DIN 11866 series B	26.9	1.60
	-	-	SMS 3008	-	-
	34.5	84.0	ASME BPE/DIN 11866 series C	19.05	1.65
	34.5	84.0	DIN 11850 series 2/DIN 11866 series A/ DIN EN 10357 series A	23.00	1.50
25	32.2	104.0	EN ISO 1127/ISO 4200/DIN 11866 series B	33.70	2.00
	32.0	94.0	SMS 3008	25.00	1.20
	32.0	94.0	BS 4825-1/ASME BPE/DIN 11866 series C	25.40	1.65
	32.0	94.0	DIN 11850 series 2/DIN 11866 series A/ DIN EN 10357 series A	29.00	1.50
32	35.8	119.0	EN ISO 1127/ISO 4200/DIN 11866 series B	42.40	2.00
	-	-	SMS 3008	-	-
	32.2	104.0	BS 4825-1/ASME BPE/DIN 11866 series C	32.00	1.65
	32.2	104.0	DIN 11850 series 2/DIN 11866 series A/ DIN EN 10357 series A	35.00	1.50
40	39.6	129.0	EN ISO 1127/ISO 4200/DIN 11866 series B	48.30	2.00
	35.8	119.0	SMS 3008	38.00	1.20
	35.8	119.0	BS 4825-1/ASME BPE/DIN 11866 series C	38.10	1.65
	35.8	119.0	DIN 11850 series 2/DIN 11866 series A/ DIN EN 10357 series A	41.00	1.50
50	45.7	148.5	EN ISO 1127/ISO 4200/DIN 11866 series B	60.30	2.60
	39.6	128.0	SMS 3008	51.00	1.20
	39.6	128.0	BS 4825-1/ASME BPE/DIN 11866 series C	50.80	1.65
	39.6	128.0	DIN 11850 series 2/DIN 11866 series A/ DIN EN 10357 series A	53.00	1.50
65	-	-	EN ISO 1127/ISO 4200/DIN 11866 series B	-	-
	45.7	147.0	SMS 3008	63.50	1.60
	45.7	147.0	BS 4825-1/ASME BPE/DIN 11866 series C	63.50	1.65
	-	-	DIN 11850 series 2/DIN 11866 series A/ DIN EN 10357 series A	-	-

Clamp connection

Note:

Specifications in mm

DIN 32676 series B, SMS 3017¹⁾, BS 4825-3/ASME BPE¹⁾ or DIN 32676 series A in stainless steel (316L - 1.4404)

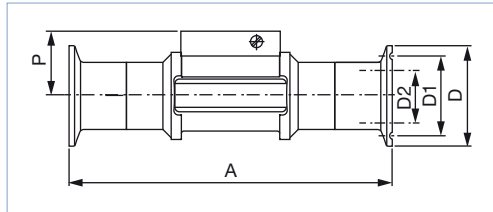

DN	P	A	Standard	D	D1	(D2)
08	-	-	DIN 32676 series B ²⁾	-	-	-
	-	-	SMS 3017	-	-	-
	-	-	ASME BPE	-	-	-
	29.5	125	DIN 32676 series A	34.0	27.5	10.00
15	34.5	130	DIN 32676 series B ²⁾	34.0	27.5	18.10
	-	-	SMS 3017	-	-	-
	-	-	ASME BPE	-	-	-
	29.5	119	DIN 32676 series A	34.0	27.5	16.00
20	32.0	150	DIN 32676 series B	50.5	43.5	23.70
	-	-	SMS 3017	-	-	-
	34.5	119	ASME BPE	25.0	19.6	15.75
	34.5	119	DIN 32676 series A	34.0	27.5	20.00
25	32.2	160	DIN 32676 series B	50.5	43.5	29.70
	32.0	129	SMS 3017	50.5	43.5	22.60
	32.0	129	BS 4825-3/ASME BPE	50.5	43.5	22.10
	32.0	136	DIN 32676 series A	50.5	43.5	26.00
32	35.8	180	DIN 32676 series B	50.5	43.5	38.40
	-	-	SMS 3017	-	-	-
	-	-	BS 4825-3/ASME BPE	-	-	-
	-	-	DIN 32676 series A	-	-	-
40	39.6	200	DIN 32676 series B	64.0	56.5	44.30
	35.8	161	SMS 3017	50.5	43.5	35.60
	35.8	161	BS 4825-3/ASME BPE	50.5	43.5	34.80
	35.8	161	DIN 32676 series A	50.5	43.5	38.00
50	45.7	230	DIN 32676 series B	77.5	70.5	55.10
	39.6	192	SMS 3017	64.0	56.5	48.60
	39.6	192	BS 4825-3/ASME BPE	64.0	56.5	47.50
	39.6	170	DIN 32676 series A	64.0	56.5	50.00
65	-	-	DIN 32676 series B	-	-	-
	45.7	216	SMS 3017	77.5	70.5	60.3
	45.7	216	BS 4825-3/ASME BPE	77.5	70.5	60.2
	-	-	DIN 32676 series A	-	-	-

1.) Available with internal surface finish Ra = 0.8 µm
 2.) Similar to DIN 32676 series B but with clamp 34.0

Flange connection

Note:

Specifications in mm

EN1092-1/B1/PN16, ANSI B16-5 or JIS 10 K in stainless steel (316L - 1.4404)

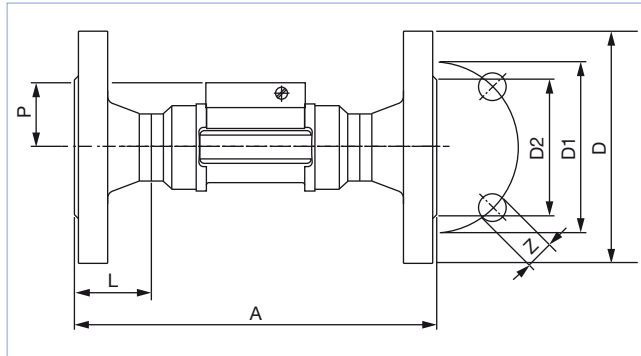

DN	P	A	Standard	L	Z	D	D1	D2				
15	34.5	130	EN	23.5	4x14.0	95.0	65.0	45.0				
		130	ANSI						4x15.8	89.0	60.3	34.9
		152	JIS						4x15.0	95.0	70.0	51.0
20	32.0	150	EN	28.5	4x14.0	105.0	75.0	58.0				
		150	ANSI						4x15.8	99.0	69.8	42.9
		178	JIS						4x15.0	100.0	75.0	56.0
25	32.2	160	EN	28.5	4x14.0	115.0	85.0	68.0				
		160	ANSI						4x15.8	108.0	79.4	50.8
		216	JIS						4x19.0	125.0	90.0	67.0
32	35.8	180	EN	31.0	4x18.0	140.0	100.0	78.0				
		180	ANSI						4x15.8	117.0	88.9	63.5
		229	JIS						4x19.0	135.0	100.0	76.0
40	39.6	200	EN	36.0	4x18.0	150.0	110.0	88.0				
		200	ANSI						4x15.8	127.0	98.4	73.0
		241	JIS						4x19.0	140.0	105.0	81.0
50	45.7	230	EN	41.0	4x18.0	165.0	125.0	102.0				
		230	ANSI						4x19.0	152.0	120.6	92.1
		267	JIS						4x19.0	155.0	120.0	96.0

4.2. Plastic sensor-fitting

True union connection with nut and solvent/fusion socket

Note:

Specifications in mm

DIN 8063, ASTM D 1785/76 or JIS K in PVC DIN 16962 in PP or ISO 10931 in PVDF

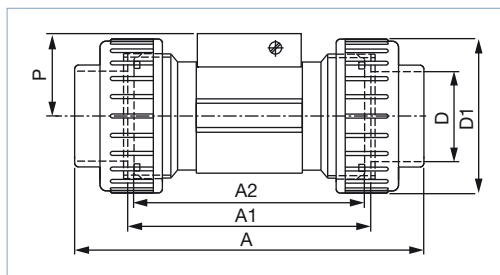

DN	P	A	Standard	A1	A2	D	D1
08 ^{1.)}	29.5	122.0	DIN/ISO	92	90	12.00	-
		-	ASTM	-	-	-	-
		-	JIS	-	-	-	-
15	34.5	128.0	DIN/ISO	96	90	20.00	43
		130.0	ASTM			21.30	
		129.0	JIS			18.40	
20	32.0	144.0	DIN/ISO	106	100	25.00	53
		145.6	ASTM			26.70	
		145.0	JIS			26.45	
25	32.2	160.0	DIN/ISO	116	110	32.00	60
		161.4	ASTM			33.40	
		161.0	JIS			32.55	
32	35.8	168.0	DIN/ISO	116	110	40.00	74
		170.0	ASTM			42.20	
		169.0	JIS			38.60	
40	39.6	188.0	DIN/ISO	127	120	50.00	83
		190.2	ASTM			48.30	
		190.0	JIS			48.70	
50	45.7	212.0	DIN/ISO	136	130	63.00	103
		213.6	ASTM			60.30	
		213.0	JIS			60.80	

1.) Only available in PVC

Solvent/fusion spigot connection

Note:

Specifications in mm

DIN 8063 in PVC, DIN 16962 in PP or ISO 10931 in PVDF

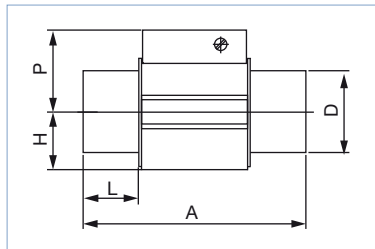

DN	P	A	Standard	L	D	H
15	34.5	90	DIN 8063	16.5	20	17.5
		85	DIN 16962	14.0		
		85	DIN 10931	14.0		
20	32.0	100	DIN 8063	20.0	25	17.5
		92	DIN 16962	16.0		
		92	DIN 10931	16.0		
25	32.2	110	DIN 8063	23.0	32	21.5
		95	DIN 16962	18.0		
		95	DIN 10931	18.0		
32	35.8	110	DIN 8063	27.5	40	27.5
		100	DIN 16962	20.0		
		100	DIN 10931	20.0		
40	39.6	120	DIN 8063	30.0	50	31.5
		106	DIN 16962	23.0		
		106	DIN 10931	23.0		
50	45.7	130	DIN 8063	37.0	63	39.5
		110	DIN 16962	27.0		
		110	DIN 10931	27.0		

5. Performance specifications

5.1. Pressure temperature diagram

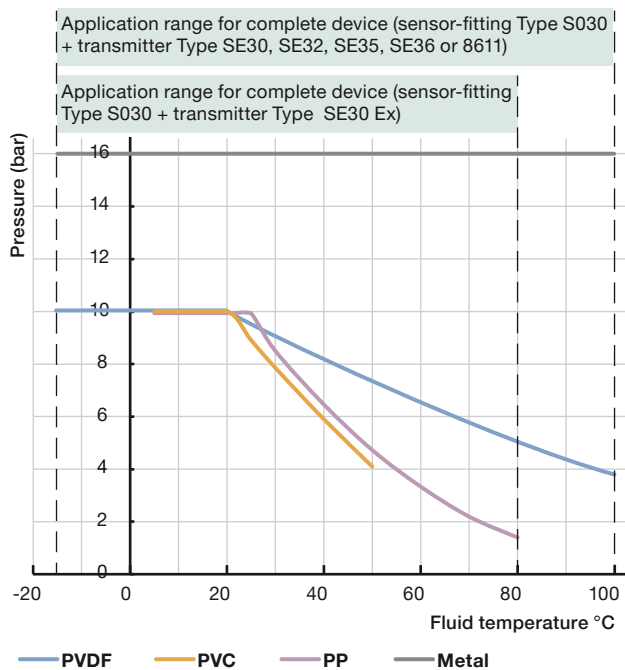

DTS 1000011766 EN Version: AF Status: RL (released | freigegeben | valide) printed: 20.11.2019

6. Product installation

6.1. Installation notes

Note:

The device is not designed for gas and steam flow measurement.

Minimum straight upstream and downstream distances must be observed. According to the pipe's design, necessary distances can be bigger or use a flow conditioner to obtain the best accuracy.

For more information, please refer to EN ISO 5167-1.

EN ISO 5167-1 prescribes the straight inlet and outlet distances that must be complied with when installing fittings in pipe lines in order to achieve calm flow conditions. The most important layouts that could lead to turbulence in the flow are shown below, together with the associated prescribed minimum inlet and outlet distances.

Make sure that the measuring conditions at the point of measurement are calm and problem-free.

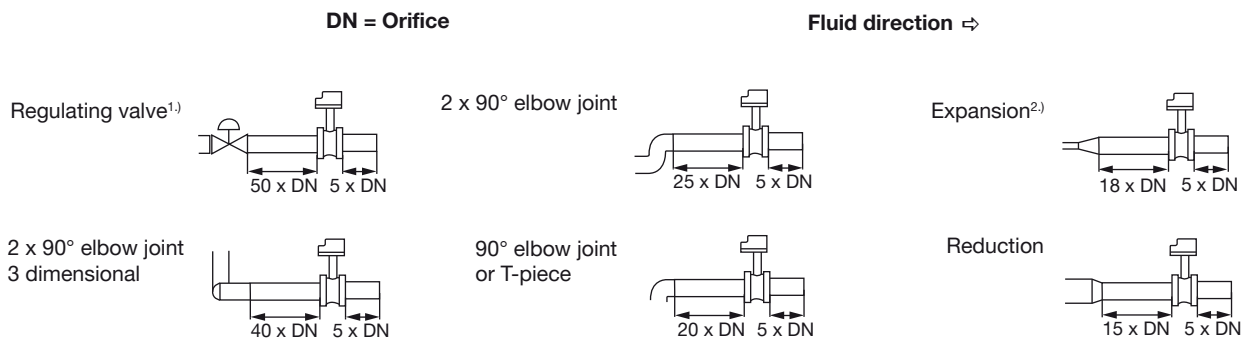

1.) If the valve cannot be mounted after the measuring device, the minimal distances have to be respected.

2.) If an expansion cannot be avoided, the minimal distances have to be respected.
Please note minimum flow velocity

The complete measuring device can be installed into either horizontal or vertical pipes.

Important criteria for this are; ensure that the measurement pipe is fully filled and that the measurement pipe is air bubble free.

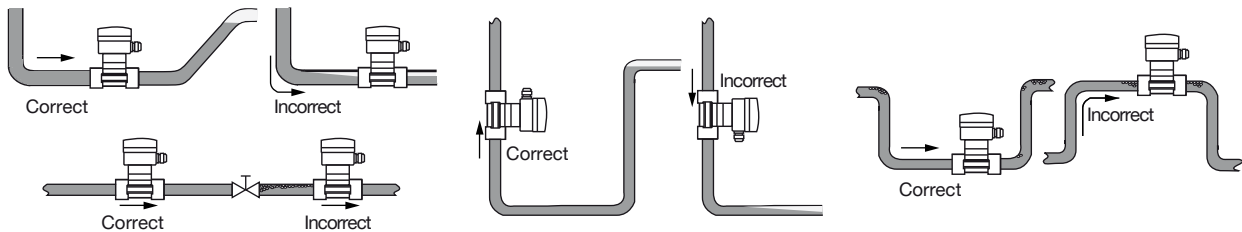

Pressure and temperature ratings must be respected according to the selected sensor-fitting material. The suitable pipe size is selected using the diagram for selecting the nominal diameter of the sensor-fitting.

See chapter "6.2. Selection of the nominal diameter" on page 11.

6.2. Selection of the nominal diameter

The following graph is used to determine the DN of the pipe and the fitting appropriate to the application, according to the fluid velocity and the flow rate. On the chart, the intersection of flow rate and flow velocity gives the appropriate diameter.

Note:

For the sensor fittings listed below, the corresponding nominal size in the bracket must be used:

- External threads acc. to SMS 1145
- Weld ends acc. to SMS 3008, BS4825-1/ASME BPE/DIN 11866 series C or DIN 11850 series 2/DIN 11866 series A/
DIN EN 10357 series A
- Clamp acc. to SMS 3017, BS 4825-3/ASME BPE or DIN 32676 series A

For all other sensor fittings, the corresponding nominal diameter without clamp applies.

Example 1:

- nominal flow: 10 m³/h
 - optimal flow rate: 2...3 m/s
- Result: Select a pipe size of DN40

Example 2 with external threads acc. to SMS 1145:

- nominal flow: 10 m³/h
 - optimal flow rate: 2...3 m/s
- Result: Select a pipe size of DN50

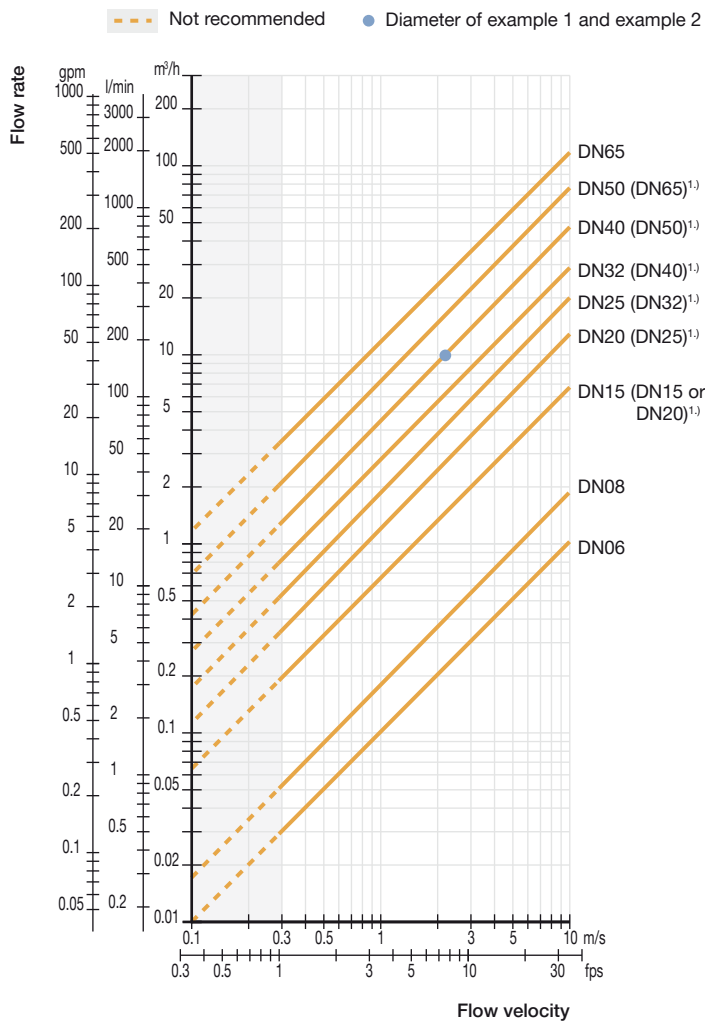

1.) See note at the beginning of this chapter.

7. Product operation

7.1. Measuring principle

When liquid flows through the pipe, the paddle wheel with 4 inserted magnets is set in rotation producing a frequency signal in the transducer (Hall sensor) of the mounted transmitter. The rotation is detected contactless through the sensor-fitting wall. The frequency signal is proportional to the flow velocity of the fluid.

8. Product design and assembly

8.1. Product assembly

Note:

- A complete device to measure the flow rate is made up of a compact Inline sensor-fitting (S030) with paddle wheel and a transmitter (SE30, SE30 Ex, SE32, SE35, SE36 or 8611).
- The Inline sensor-fitting (S030) ensures simple installation into pipes from DN06...DN65. The transmitter can easily be installed into any Bürkert sensor-fitting system (S030), by means of a quarter turn.
- The drawing shows the assembly of a sensor-fitting Type S030 with a process True union connection with nut and solvent/fusion socket and a transmitter Type SE32 (Type S030 + Type SE32 = Type 8032). This also applies to all versions of process connection and compatible type of transmitter.

See **Data sheet Type 8030** ▶ Inline flowmeter, **Data sheet Type 8032** ▶ Flowmeter/threshold detector, **Data sheet Type 8035** ▶ Inline flowmeter or batch controller, **Data sheet Type 8036** ▶ Inline flowmeter, ELEMENT design or **Data sheet Type 8611** ▶ eCONTROL - Universal controller for more information.

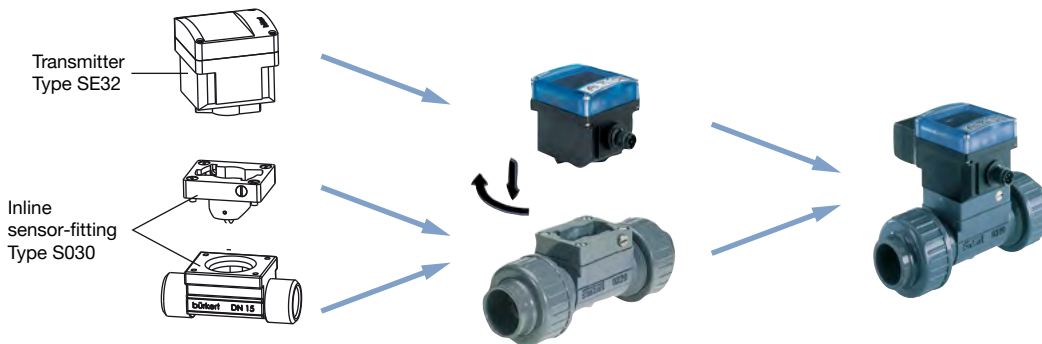

9. Product accessories

Note:

Since March 2012, sensor-fittings Type S030 in DN15 and DN20 exist in two versions, that have different K factors. The second version is identified by the marking "v2".

This "v2" marking can be found:

- on the bottom of the DN15 or DN20 sensor-fitting in plastic



- on the side of the DN15 or DN20 sensor-fitting in metal

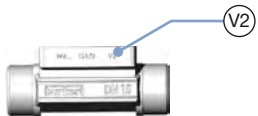

Accessory	No.	Description
	1	Sensor holder
	2	O-ring set for metal sensor-fitting
	3	O-ring set for plastic sensor-fitting (O-Ring for process connection and seal ^{1.)} for sensor holder).
1.) Depending on sensor holder version: flat seal to use for holder with groove (old version, no more available for sale), O-Ring to use for holder with lug (version "v2")		

10. Networking and combination with other Bürkert products

Example:



Transmitter



Type SE30 ▶
Flow transmitter
for Inline
sensor-fitting



Type SE30 Ex ▶
Flow transmitter
for hazardous
areas



Type SE32 ▶
Flow transmitter
for Inline
sensor-fitting



Type SE35 ▶
Flow transmitter
for Inline
sensor-fitting



Type SE35 ▶
Batch controller
for Inline
sensor-fitting



Type SE36 ▶
ELEMENT trans-
mitter for Inline
sensor-fitting



Type 8611 ▶
eCONTROL -
Universal
controllers

Flowmeter/Threshold detector/ Batch controller/Universal controller



Type 8030 ▶
Inline flowmeter



Type SE30 Ex ▶
Inline flowmeter
for hazardous
areas



Type 8032 ▶
Inline flowme-
ter/threshold
detector



Type 8035 ▶
Inline flowmeter



Type 8035 ▶
Inline batch
controller



Type 8036 ▶
Inline flowmeter,
ELEMENT
design



Type 8611 ▶
eCONTROL -
Inline Universal
controllers

PNP/NPN output or current modulation according to NAMUR^{1.)}



Type 8619 ▶
multiCELL - transmitter/controller



Type 8025 ▶
Flow transmitter



Type 8611 ▶
eCONTROL - Universal controller
panel, wall or rail-mounting version

1.) Only for SE30Ex: depending on the category, to be used with an intrinsic safety barrier with NAMUR input

11. Ordering information

11.1. Bürkert eShop – Easy ordering and quick delivery



Bürkert eShop – Easy ordering and fast delivery

You want to find your desired Bürkert product or spare part quickly and order directly? Our online shop is available for you 24/7. Sign up and enjoy all the benefits.

[Order online now](#)

11.2. Recommendation regarding product selection

A complete device to measure the flow rate is made up of a compact Inline sensor-fitting (S030) with paddle wheel and a transmitter (SE30, SE30 Ex, SE32, SE35, SE36 or 8611).

Two different components must be ordered in order to select a complete device. The following information is required:

- **Article no.** of the desired flow transmitter (see [Data sheet Type 8030](#) ▶, [Data sheet Type 8032](#) ▶, [Data sheet Type 8035](#) ▶, [Data sheet Type 8036](#) ▶ or [Data sheet Type 8611](#) ▶)
- **Article no.** of the selected S030 Inline sensor-fitting (see chapter [“11.4. Ordering chart”](#) on page 16)

11.3. Bürkert product filter



Bürkert product filter – Get quickly to the right product

You want to select products comfortably based on your technical requirements? Use the Bürkert product filter and find suitable articles for your application quickly and easily.

[Try out our product filter](#)

11.4. Ordering chart

Metal sensor-fitting

Standard	Article no.									
	DN06 ^{1.)} - ¼"	DN06 ^{1.)} - ½"	DN08 ^{1.)} - ½"	DN15	DN20	DN25	DN32	DN40	DN50	DN65
Brass - with PVDF paddle wheel - Fluid temperature max. 100 °C, PN16										
FKM seal										
Internal thread connection										
G	-	-	-	423980	423981	423982	423983	423984	423985	-
NPT	-	-	-	423986	423987	423988	423989	423990	423991	-
Rc	-	-	-	423992	423993	423994	423995	423996	423997	-
External thread connection										
G	552557	552527	444023	423998	423999	424000	424001	-	-	-
NPT	-	-	449182	-	-	-	-	-	-	-
Rc	-	-	448668	-	-	-	-	-	-	-
Stainless steel - with PVDF paddle wheel - Fluid temperature max. 100 °C, PN16										
FKM seal										
Internal thread connection										
G	-	-	-	424004	424005	424006	424007	424008	424009	-
NPT	-	-	-	424010	424011	424012	424013	424014	424015	-
Rc	-	-	-	424016	424017	424018	424019	424020	424021	-
External thread connection										
G	552733	552559	444029	424022	424023	424024	424025	-	-	-
NPT	-	-	449050	-	-	-	-	-	-	-
Rc	-	-	448669	-	-	-	-	-	-	-
Weld end connection										
EN ISO 1127/ ISO 4200/ DIN 11866 series B	-	-	552845 ^{3.)}	424028	424029	424030	424031	424032	424033	-
Clamp connection										
DIN 32676 series B	-	-	-	424034 ^{4.)}	424035	424036	424037	424038	424039	-
Flange connection										
EN 1092-1/B1/ PN16	-	-	-	424040	424041	424042	424043	424044	424045	-
ANSI B16-5	-	-	-	424046	424047	424048	424049	424050	424051	-
JIS 10K	-	-	-	430108	430109	430110	430111	430112	430113	-
EPDM seal										
External thread connection										
SMS 1145	-	-	-	-	-	443306	-	443307	443308	-
Weld end connection										
SMS 3008	-	-	-	-	-	443298	-	443299	443300	443374 ^{6.)}
BS 4825-1/ ASME BPE/ DIN 11866 series C	-	-	-	-	443369 ^{5.)}	443370	443371	443372	443373	443374
DIN 11850 series 2/ DIN 11866 series A/ DIN EN 10357 series A	-	-	551788	551789	551790	551791	-	551792	551793	-
Clamp connection										
SMS 3017	-	-	-	-	-	443302	-	443303	443304	443399 ^{6.)}
SMS 3017 ^{2.)}	-	-	-	-	-	443387	-	443388	443389	443720 ^{6.)}
BS 4825-3/ ASME BPE	-	-	-	-	443395 ^{5.)}	443396	-	443397	443398	443399
BS 4825-3/ ASME BPE ^{2.)}	-	-	-	-	443400	443717	-	443718	443719	443720

DTS 1000011766 EN Version: AF Status: RL (released | freigegeben | valide) printed: 20.11.2019

Standard	Article no.									
	DN06 ^{1.)} - 1/4"	DN06 ^{1.)} - 1/2"	DN08 ^{1.)} - 1/2"	DN15	DN20	DN25	DN32	DN40	DN50	DN65
DIN 32676 series A	-	-	551794	551795	551796	551797	-	551798	551799	-
Stainless steel - with PVDF paddle wheel - Fluid temperature max. 100 °C, PN40										
FKM seal										
Internal thread connection										
G	-	-	-	427138	425737	425729	427152	427153	427154	-

- 1.) External thread
- 2.) Internal surface finish Ra = 0.8 µm
- 3.) EPDM seal
- 4.) Refer to Clamp with D dimensions of 34 mm (see chapter "Clamp connection" on page 8)
- 5.) DN20 only available in ASME BPE
- 6.) Please refer to ASME BPE

Further versions on request

Process connection
 External thread connection: Metric in mm

Plastic sensor-fitting

Standard	Article no.									
	DN06 ^{1.)} - 1/4"	DN06 ^{1.)} - 1/2"	DN08 ^{1.)} - 1/2"	DN15	DN20	DN25	DN32	DN40	DN50	DN65
PVC - with PVDF paddle wheel - Fluid temperature max. 50 °C, PN10										
FKM seal										
True union connection with nut and solvent socket										
DIN 8063	-	-	444022	423938	423939	423940	423941	423942	423943	-
ASTM D 1785/76	-	-	-	423950	423951	423952	423953	423954	423955	-
JIS K	-	-	-	429072	429073	429074	429075	429076	429077	-
Solvent spigot connection										
DIN 8063	-	-	-	423944	423945	423946	423947	423948	423949	-
External thread connection										
G	-	552560	444025	-	-	-	-	-	-	-
True union connection with nut and without socket										
-	-	-	-	430734	430735	430736	430737	430738	430739	-
EPDM seal										
True union connection with nut and without socket										
-	-	-	-	430740	430741	430742	430743	430744	430745	-
PP - with PVDF paddle wheel - Fluid temperature max. 80 °C, PN10										
FKM seal										
True union connection with nut and fusion socket										
DIN 16962	-	-	-	423956	423957	423958	423959	423960	423961	-
Fusion spigot connection										
DIN 16962	-	-	-	423962	423963	423964	423965	423966	423967	-
PVDF - with PVDF paddle wheel - Fluid temperature max. 100 °C, PN10										
FKM seal										
True union connection with nut and fusion socket										
ISO 10931	-	-	-	423968	423969	423970	423971	423972	423973	-
Fusion spigot connection										
ISO 10931	-	-	-	423974	423975	423976	423977	423978	423979	-
External thread connection										
ISO 10931	-	-	444028	-	-	-	-	-	-	-

- 1.) External thread











































DTS 1000011766 EN Version: AF Status: RL (released | freigegeben | valide) printed: 20.11.2019

11.5. Ordering chart accessories

Note:

Since March 2012, sensor-fittings Type S030 in DN15 and DN20 exist in two versions, that have different K factors. The second version is identified by the marking "v2".

See chapter "9. Product accessories" on page 13.

Description	Article no.
Sensor holder	
Stainless steel with paddle wheel (PVDF), seal (FKM), screws and certificate for DN06, DN08, DN15 v2 and DN20 v2	448678 
Stainless steel with paddle wheel (PVDF), seal (FKM), screws and certificate for DN15 (except DN15 v2 and DN20 v2)...DN65	432306 
Stainless steel with paddle wheel (PVDF), seal (EPDM), screws and certificate for DN15 (except DN15 v2 and DN20 v2)...DN65	432305 
Stainless steel with paddle wheel (PVDF), seal (EPDM), screws and certificate, Ra int. = 0.8 µm for DN15 (except DN15 v2 and DN20 v2)...DN65	434149 
Stainless steel with paddle wheel (PP), seal (EPDM), screws and certificate for DN06, DN08, DN15 v2 and DN20 v2	554896 
Stainless steel with paddle wheel (PP), seal (EPDM), screws and certificate for DN15 (except DN15 v2 and DN20 v2)...DN65	449425 
Brass with paddle wheel (PVDF), seal (FKM), screws and certificate for DN06, DN08, DN15 v2 and DN20 v2	448677 
Brass with paddle wheel (PVDF), seal (FKM), screws and certificate for DN15 (except DN15 v2 and DN20 v2)...DN65	432304 
Brass with paddle wheel (PVDF), seal (EPDM), screws and certificate for DN15 (except DN15 v2 and DN20 v2)...DN65	432303 
Brass with paddle wheel (PP), seal (EPDM), screws and certificate for DN15 (except DN15 v2 and DN20 v2)...DN65	449866 
PVC with paddle wheel (PVDF), seal (FKM), screws and certificate for DN06, DN08, DN15 v2 and DN20 v2	448674 
PVC with paddle wheel (PVDF), seal (FKM), screws and certificate for DN15 (except DN15 v2 and DN20 v2)...DN65	432298 
PVC with paddle wheel (PVDF), seal (EPDM), screws and certificate for DN15 (except DN15 v2 and DN20 v2)...DN65	432297 
PVC with paddle wheel (PP), seal (EPDM), screws and certificate for DN15 (except DN15 v2 and DN20 v2)...DN65	443982 
PP with paddle wheel (PVDF), seal (FKM), screws and certificate for DN15...DN65	432300 
PP with paddle wheel (PVDF), seal (EPDM), screws and certificate for DN15...DN65	432299 
PP with paddle wheel (PP), seal (FKM), screws and certificate for DN15...DN65	552881 
PP with paddle wheel (PP), seal (EPDM), screws and certificate for DN15...DN65	443983 
PVDF with paddle wheel (PVDF), seal (FKM), screws and certificate for DN06, DN08, DN15 v2 and DN20 v2	448676 
PVDF with paddle wheel (PVDF), seal (FKM), screws and certificate for DN15 (except DN15 v2 and DN20 v2)...DN65	432302 
PVDF with paddle wheel (PVDF), seal (EPDM), screws and certificate for DN15 (except DN15 v2 and DN20 v2)...DN65	432301 
O-ring set	
FKM - for metal sensor-fitting, DN06...DN65	426340 
EPDM - for metal sensor-fitting, DN06...DN65	426341 
FKM - for plastic sensor-fitting, DN08	448679 
FKM - for plastic sensor-fitting, DN15	431555 
FKM - for plastic sensor-fitting, DN20	431556 
FKM - for plastic sensor-fitting, DN25	431557 
FKM - for plastic sensor-fitting, DN32	431558 
FKM - for plastic sensor-fitting, DN40	431559 
FKM - for plastic sensor-fitting, DN50	431560 
EPDM - for plastic sensor-fitting, DN08	448680 
EPDM - for plastic sensor-fitting, DN15	431561 
EPDM - for plastic sensor-fitting, DN20	431562 
EPDM - for plastic sensor-fitting, DN25	431563 
EPDM - for plastic sensor-fitting, DN32	431564 
EPDM - for plastic sensor-fitting, DN40	431565 
EPDM - for plastic sensor-fitting, DN50	431566 
Approvals/Certificates	
Inspection certificate 3.1 (acc. to EN-ISO 10204)	803723 
Test report 2.2 (acc. to EN-ISO 10204)	803722 
Certification of Conformity for the surface Quality (DIN4762-DIN4768-ISO/4287/1)	804175 
3 points Flow calibration certificate (S020 combined with the flow device inserted, only for DN ≤200)	550676 
FDA approval	803724 

Bürkert – Close to You

For up-to-date addresses
please visit us at
www.burkert.com

DTS 1000011766 EN Version: AF Status: RL (released | freigegeben | validé) printed: 20.11.2019

